

# 6MBI35S-140

IGBT Modules

## IGBT MODULE ( S series) 1400V / 35A 6 in one-package

### Features

- Compact Package
- P.C.Board Mount Module
- Low  $V_{CE(sat)}$

### Applications

- Inverter for Motor drive
- AC and DC Servo drive amplifier
- Uninterruptible power supply
- Industrial machines, such as Welding machines

### Maximum ratings and characteristics

#### Absolute maximum ratings (at $T_c=25^\circ\text{C}$ unless otherwise specified)

| Item                              | Symbol      | Rating                 | Unit             |     |   |
|-----------------------------------|-------------|------------------------|------------------|-----|---|
| Collector-Emitter voltage         | $V_{CES}$   | 1400                   | V                |     |   |
| Gate-Emitter voltage              | $V_{GES}$   | $\pm 20$               | V                |     |   |
| Collector current                 | Continuous  | $T_j=25^\circ\text{C}$ | $I_c$            | 50  | A |
|                                   |             | $T_j=75^\circ\text{C}$ |                  | 35  |   |
|                                   | 1ms         | $T_j=25^\circ\text{C}$ | $I_c$ pulse      | 100 | A |
|                                   |             | $T_j=75^\circ\text{C}$ |                  | 70  |   |
|                                   |             |                        | $-I_c$           | 35  | A |
|                                   | 1ms         |                        | $-I_c$ pulse     | 70  | A |
| Max. power dissipation (1 device) | $P_c$       | 240                    | W                |     |   |
| Operating temperature             | $T_j$       | +150                   | $^\circ\text{C}$ |     |   |
| Storage temperature               | $T_{stg}$   | -40 to +125            | $^\circ\text{C}$ |     |   |
| Isolation voltage *1              | $V_{is}$    | AC 2500 (1min.)        | V                |     |   |
| Screw torque                      | Mounting *2 | 3.5                    | N·m              |     |   |

\*1: All terminals should be connected together when isolation test will be done.

\*2: Recommendable value : 2.5 to 3.5 N·m (M5)

#### Electrical characteristics (at $T_j=25^\circ\text{C}$ unless otherwise specified)

| Item                                 | Symbol        | Characteristics |      |      | Conditions  | Unit                                   |   |
|--------------------------------------|---------------|-----------------|------|------|---|--|---|
|                                      |               | Min.            | Typ. | Max. |   |  |   |
| Zero gate voltage collector current  | $I_{CES}$     | -               | -    | 1.0  | $V_{GE}=0\text{V}$ , $V_{CE}=1400\text{V}$  | mA                                     |   |
| Gate-Emitter leakage current         | $I_{GES}$     | -               | -    | 0.2  | $V_{CE}=0\text{V}$ , $V_{GE}=\pm 20\text{V}$  | $\mu\text{A}$                          |   |
| Gate-Emitter threshold voltage       | $V_{GE(th)}$  | 5.5             | 7.2  | 8.5  | $V_{CE}=20\text{V}$ , $I_c=35\text{mA}$   | V                                      |   |
| Collector-Emitter saturation voltage | $V_{CE(sat)}$ | -               | 2.4  | 2.75 | $T_j=25^\circ\text{C}$  | $V_{GE}=15\text{V}$ , $I_c=35\text{A}$ | V |
|                                      |               | -               | 3.0  | -    | $T_j=125^\circ\text{C}$   |  |   |
| Input capacitance                    | $C_{ies}$     | -               | 4200 | -    | $V_{GE}=0\text{V}$  | pF                                     |   |
| Output capacitance                   | $C_{oes}$     | -               | 875  | -    | $V_{CE}=10\text{V}$   |  |   |
| Reverse transfer capacitance         | $C_{res}$     | -               | 770  | -    | $f=1\text{MHz}$   |  |   |
| Turn-on time                         | $t_{on}$      | -               | 0.35 | 1.2  | $V_{CC}=800\text{V}$<br>$I_c=35\text{A}$<br>$V_{GE}=\pm 15\text{V}$<br>$R_G=33\Omega$ | $\mu\text{s}$                          |   |
|                                      | $t_r$         | -               | 0.25 | 0.6  |   |  |   |
|                                      | $t_{r(i)}$    | -               | 0.1  | -    |   |  |   |
| Turn-off time                        | $t_{off}$     | -               | 0.45 | 1.0  |   |  |   |
|                                      | $t_f$         | -               | 0.08 | 0.3  |   |  |   |
| Diode forward on voltage             | $V_F$         | -               | 2.6  | 3.4  | $T_j=25^\circ\text{C}$  | $I_F=35\text{A}$ , $V_{GE}=0\text{V}$  | V |
|                                      |               | -               | 2.2  | -    | $T_j=125^\circ\text{C}$   |  |   |
| Reverse recovery time                | $t_{rr}$      | -               | -    | 0.35 | $I_F=35\text{A}$  | $\mu\text{s}$                          |   |

#### Thermal resistance characteristics

| Item               | Symbol          | Characteristics |      |      | Conditions              | Unit               |
|--------------------|-----------------|-----------------|------|------|-------------------------|--------------------|
|                    |                 | Min.            | Typ. | Max. |                         |                    |
| Thermal resistance | $R_{th(j-c)}$   | -               | -    | 0.52 | IGBT                    | $^\circ\text{C/W}$ |
|                    | $R_{th(j-c)}$   | -               | -    | 0.90 | FWD                     | $^\circ\text{C/W}$ |
|                    | $R_{th(c-f)*2}$ | -               | 0.05 | -    | the base to cooling fin | $^\circ\text{C/W}$ |

\*2 : This is the value which is defined mounting on the additional cooling fin with thermal compound



### Equivalent Circuit Schematic

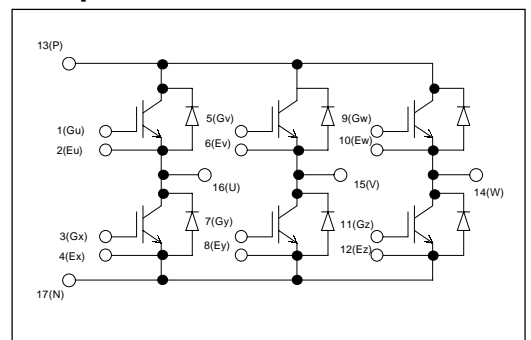

■ Characteristics

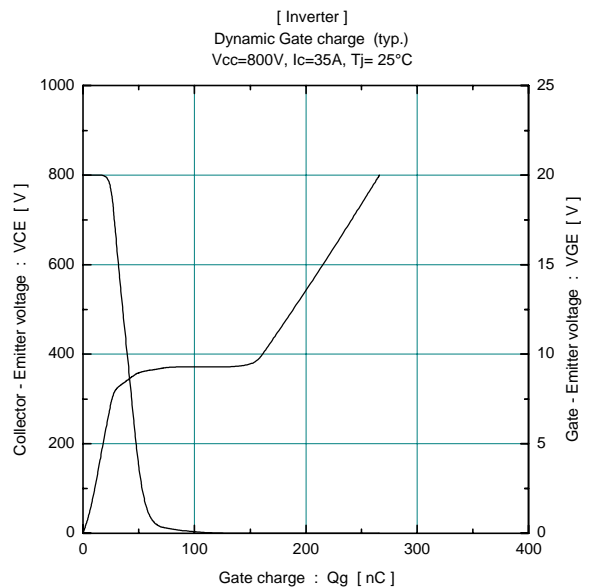
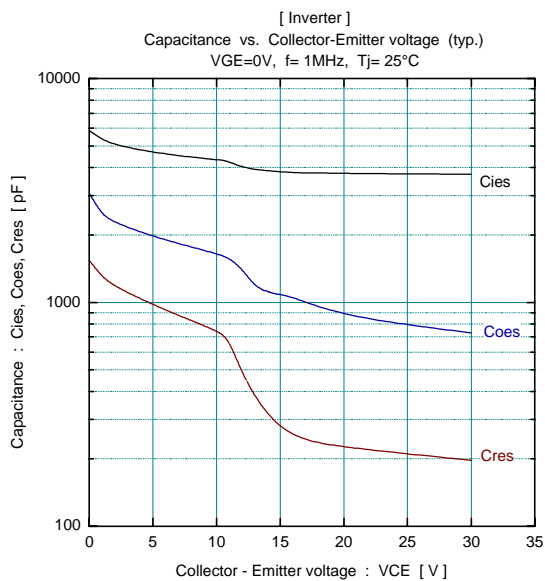
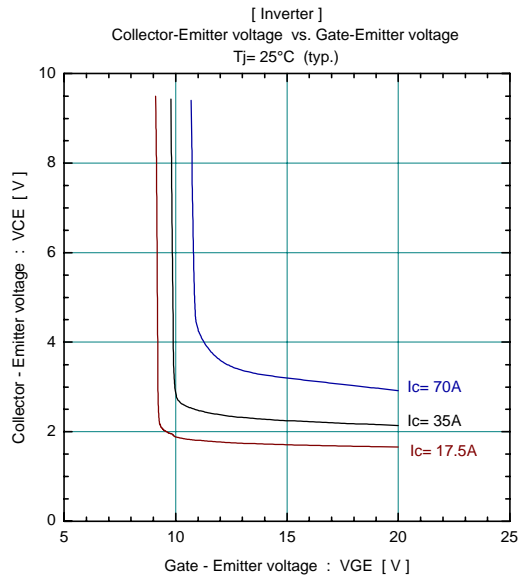
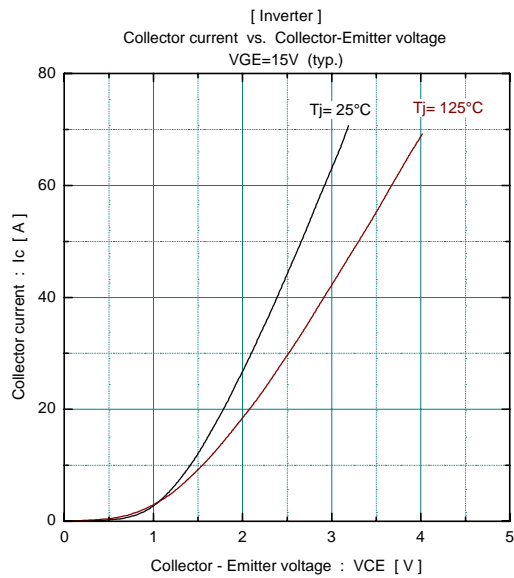
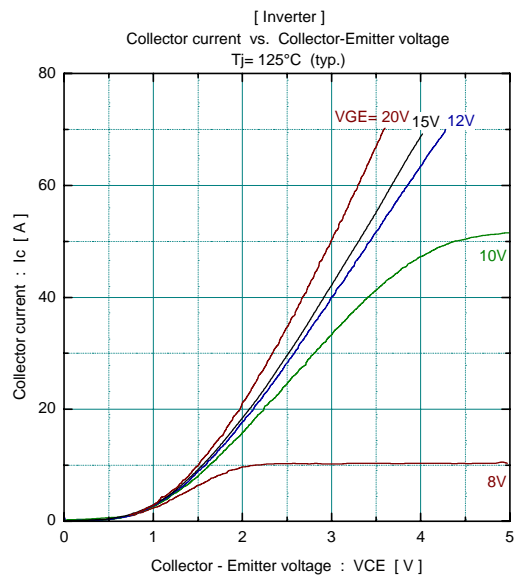
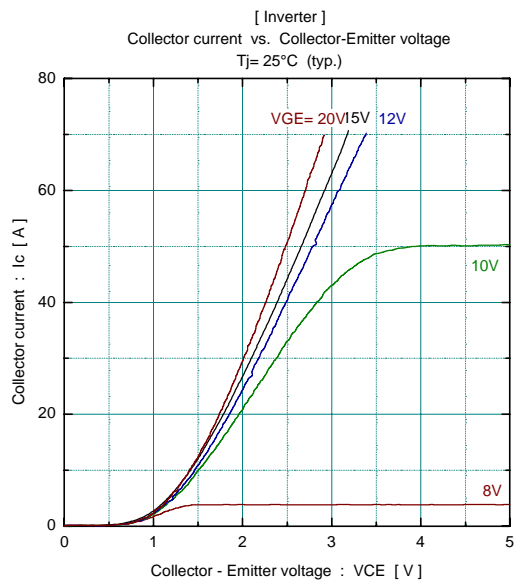

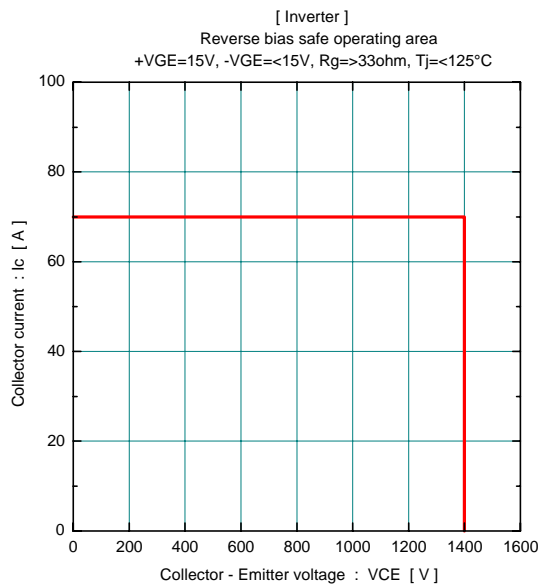
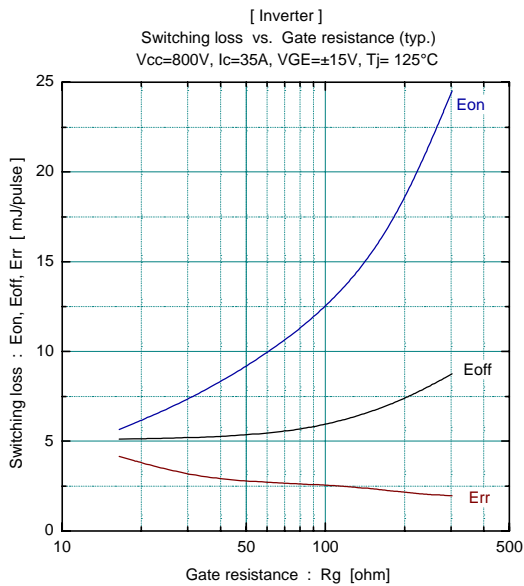
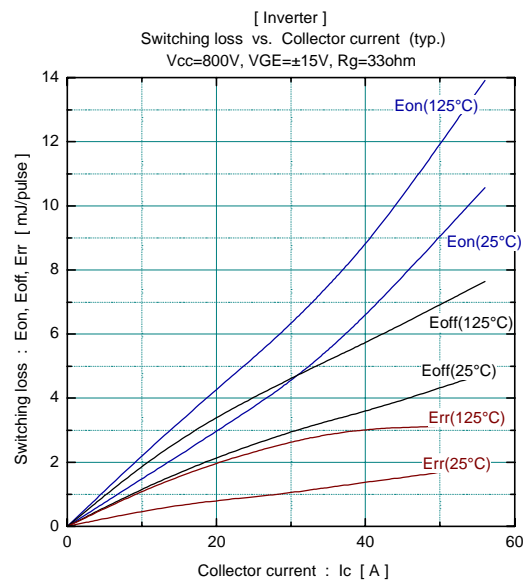
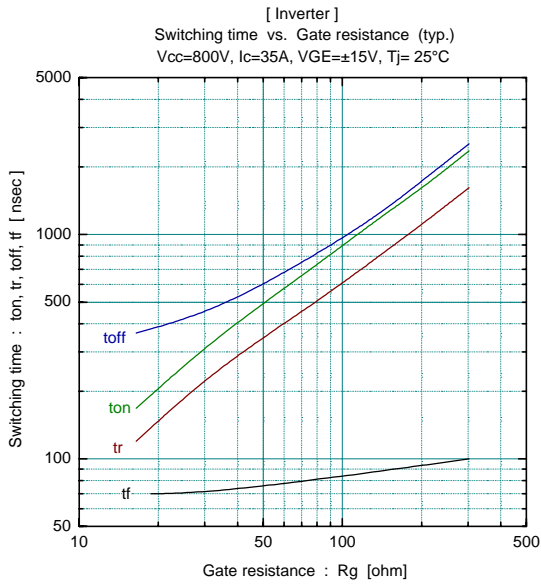
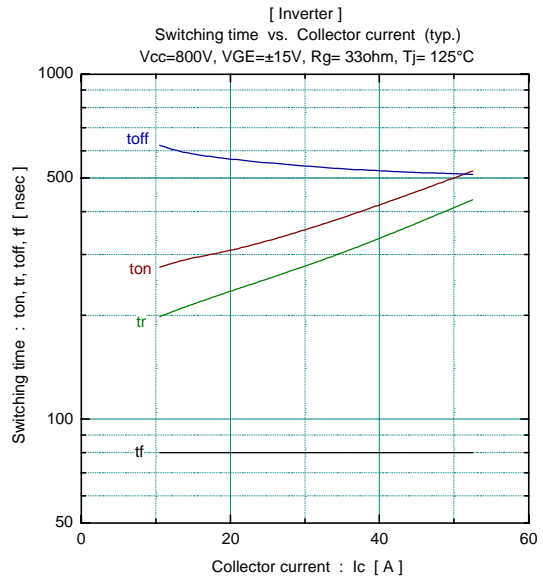
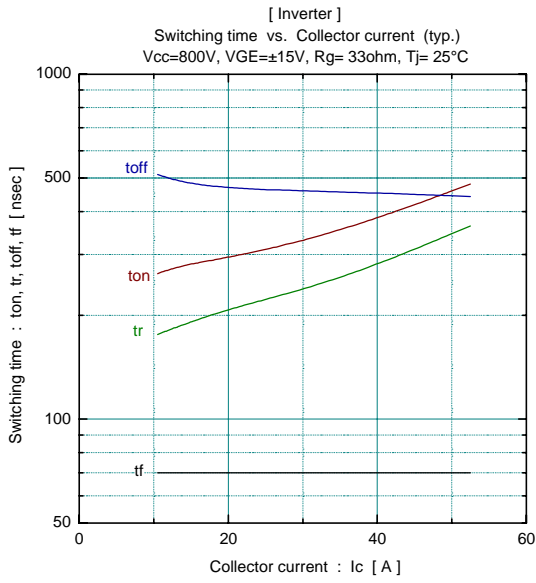

Forward current vs. Forward on voltage (typ.)

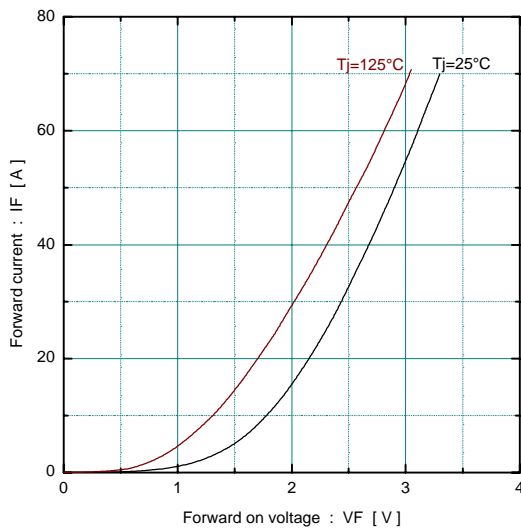

Reverse recovery characteristics (typ.)  
Vcc=800V, VGE=±15V, Rg=33ohm

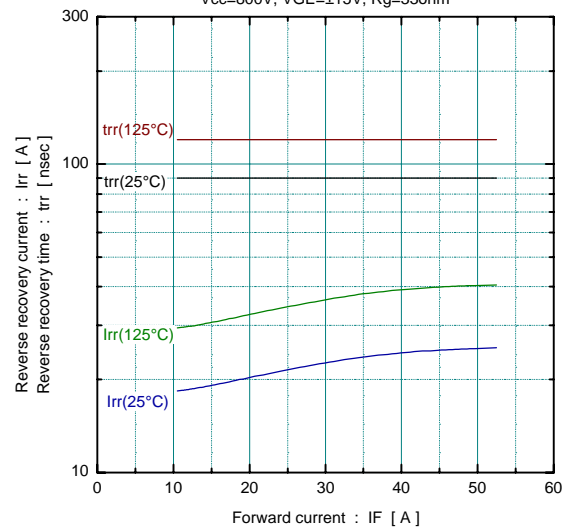

Transient thermal resistance

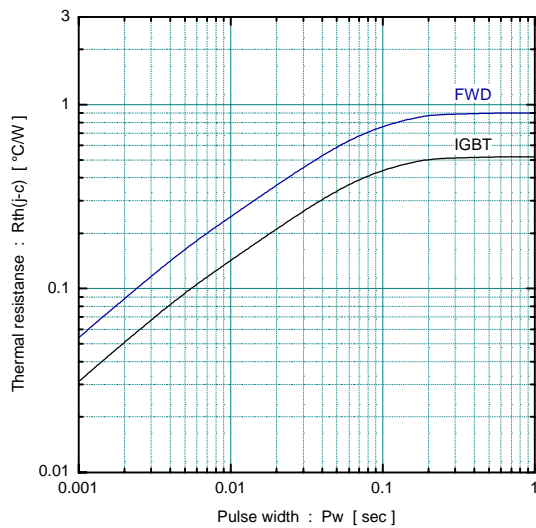

■ Outline Drawings, mm

mass : 180g

